

**MERIVOBX** Lade - spoelbaklade - sifonlade

Firma		Telefoon	
Gemeente		E-mail	
Commissie		Levertijd	

<b>Ladezijden</b> <input type="radio"/> zijdewit <input type="radio"/> oriongrijs <input type="radio"/> indiumgrijs	<b>Bodem + rug</b> <input type="radio"/> zijdewit <input type="radio"/> oriongrijs <input type="radio"/> indiumgrijs	<b>Bewegingstype</b> <input type="radio"/> BLUMOTION <input type="radio"/> TIP-ON BLUMOTION	<b>Frontbevestiging</b> <input type="radio"/> EXPANDO <input type="radio"/> schroefversie <input type="radio"/> INSERTA <input type="radio"/> EXPANDO T <input type="radio"/> drevel <input type="radio"/> Voor Alu front
--	---	---	---

<b>Opvullijst <sup>(1)</sup></b> <input type="radio"/> wit <input type="radio"/> platina zilvergrijs <input type="radio"/> oriongrijs <input type="radio"/> zwart	<b>Verpakking</b> <input type="radio"/> V1 <input type="radio"/> ProBOX <sup>(2)</sup>	<b>Inlegmatten</b> <input type="radio"/> antislip-fiber <input type="radio"/> wit <input type="radio"/> grijs <input type="radio"/> zwart <hr/> <input type="radio"/> vinyl-fiber <input type="radio"/> quartz <input type="radio"/> bister <hr/> <input type="radio"/> Flock <input type="radio"/> grijs <input type="radio"/> zwart
---	--	---

Specificaties											
Nr.	Aantal	Ladetype <sup>(3)</sup>	Breedte corpus		Ladediepte	Draagkracht (4)	Zijwand E (5)	Front E (6)	Opties		
			Binnenbreedte	Opvullijst					Stabilisator (7)	Dwarsreling	meenemer-set (8)
1			mm	<input type="radio"/> 1 <input type="radio"/> 2	mm	kg					
2			mm	<input type="radio"/> 1 <input type="radio"/> 2	mm	kg					
3			mm	<input type="radio"/> 1 <input type="radio"/> 2	mm	kg					
4			mm	<input type="radio"/> 1 <input type="radio"/> 2	mm	kg					
5			mm	<input type="radio"/> <input type="radio"/>	mm	kg					
6			mm	<input type="radio"/> 1 <input type="radio"/> 2	mm	kg					

Specificaties - uitbreiding sifonlade <sup>(11)</sup>					
Type lade	Enkel-dubbel	Enkel-dubbel		Dubbel	Enkel-dubbel
Nr.	X <sup>(9)</sup>	Z1 <sup>(11)</sup>		M <sup>(10)</sup>	Y <sup>(9)</sup>
	mm	<input type="radio"/> 160 mm	<input type="radio"/> 300 mm	mm	<input type="radio"/> 160 mm <input type="radio"/> 300 mm
	mm	<input type="radio"/> 160 mm	<input type="radio"/> 300 mm	mm	<input type="radio"/> 160 mm <input type="radio"/> 300 mm
	mm		<input type="radio"/> 350 mm	mm	<input type="radio"/> 350 mm
	mm		<input type="radio"/> 350 mm	mm	<input type="radio"/> 350 mm

Specificaties - uitbreiding spoelbaklade					
Type lade	Links	Uitsparing		Rechts	NLS*
Nr.	X <sup>(12)</sup>	Z1 <sup>(11)</sup>		Y <sup>(9)</sup>	*NL-NLS=minimum 150mm
	mm	<input type="radio"/> 470 mm	<input type="radio"/> 570 mm <input type="radio"/> 770 mm	mm	

**NODIGE INBOUWRUIMTE**

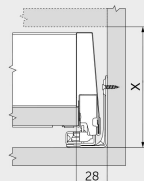

X	Min.
N	85,5
M	108
K	146
E	209

Incl. vrije ruimte om de lade in te hangen.  
 Incl. neigingsverstelling.  
 Binnenlade met meenemer +5 mm.

- (1) Symmetrisch profiel, dikte 25 mm  
 (2) Minimale bestelhoeveelheid: 4 stuks  
 (3) Zie volgende pagina's  
 (4) De draagkracht is ook afhankelijk van de lengte: zie tabel volgende pagina  
 (5) R: reling, BCOV: boxcover, BCAP: boxcap  
 (6) R: reling, GH: glas hoog, GL: glas laag  
 (7) Wordt aanbevolen bij brede, ondiepe lades  
 (8) Enkel voor metalen binnenladefronten  
 (9) X en Y kunnen variabel zijn, maar moeten minimaal 114 mm zijn  
 (10) Kan variabel zijn, maar moet minimaal 97 mm zijn  
 (11) 160 mm en 300 mm met M rugwand, 3350 mm met E rugwand  
 (12) X en Y kunnen variabel zijn, maar moeten minimaal 125 mm zijn

Opmerking:

## Maatvoering

### MERIVOBX LADE BLUMOTION of TIP-ON BLUMOTION

LADEDIEPTE + GEWICHT

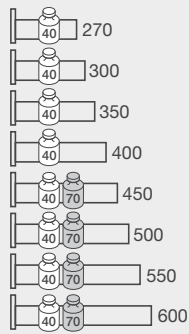

niet beschikbaar  
N - K

N

N

### MERIVOBX SPOELBAKLADE BLUMOTION of TIP-ON BLUMOTION

niet beschikbaar

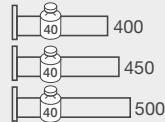

N

N

N

### MERIVOBX SIFONLADE BLUMOTION of TIP-ON BLUMOTION

niet beschikbaar

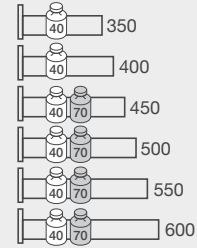

N

N

N

N

N

N

### MAATVOERING SPOELBAKLADE

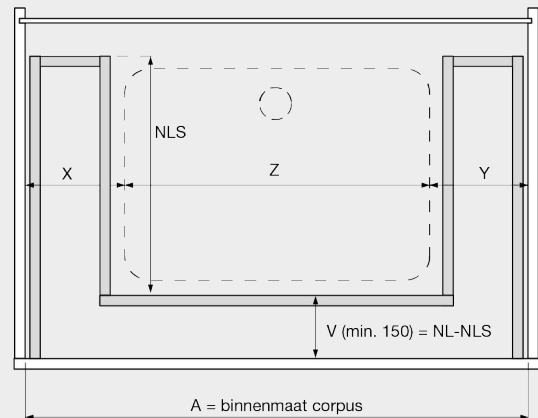
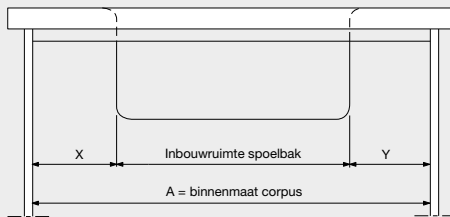

### MAATVOERING ENKELE SIFONLADE

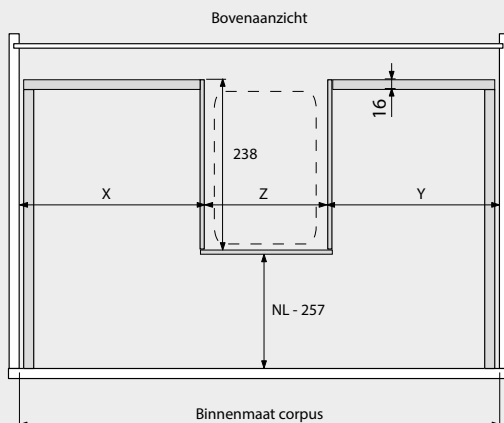

### MAATVOERING DUBBELE SIFONLADE

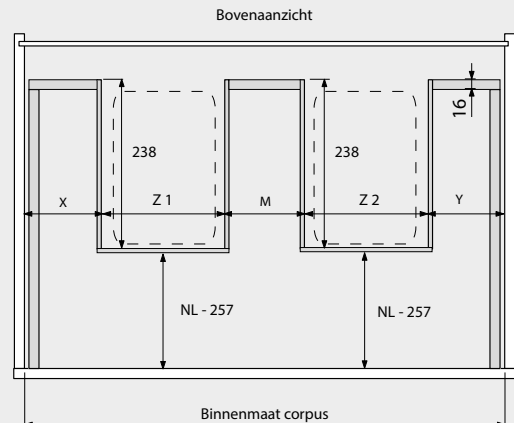

Lade

LADES

N

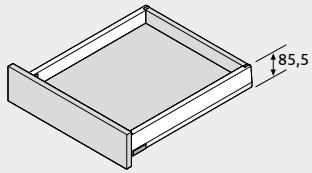

E boxcap

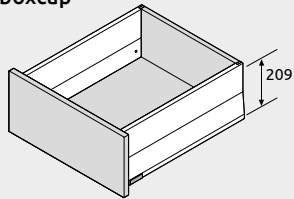

M

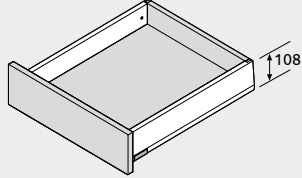

E boxcover

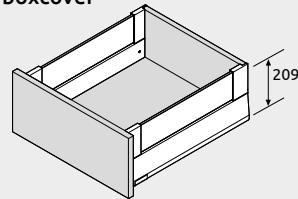

K

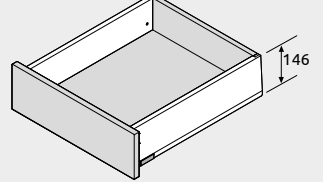

E reling

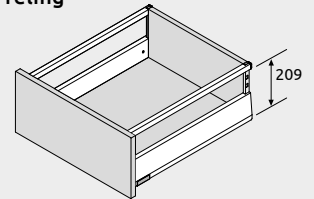

BINNENLADES

M/Z

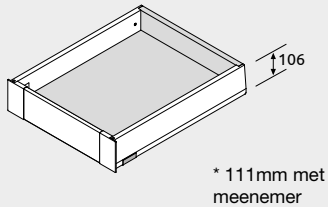

E/Z boxcap - laag glas

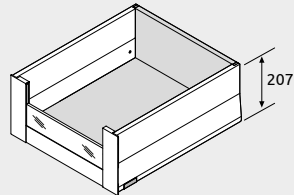

K/Z

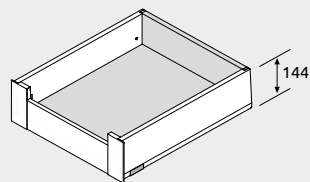

E/Z boxcap - hoog glas

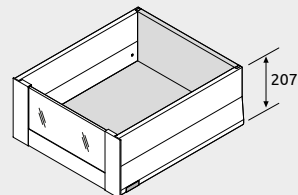

E/Z boxcap - reling

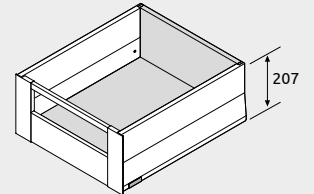

E/Z boxcover - reling

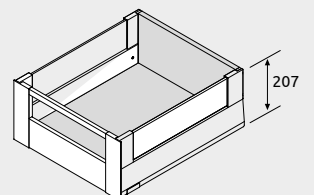

E/Z boxcover - laag glas

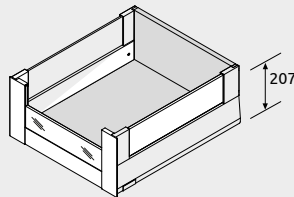

E/Z boxcover - hoog glas

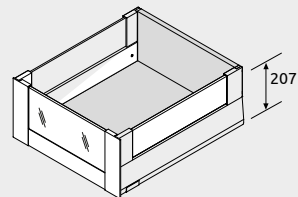

E/Z reling - reling

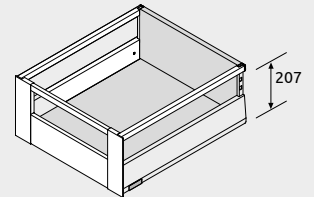

E/Z reling - glas laag

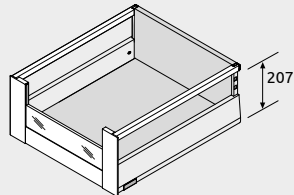

E/Z reling - glas hoog

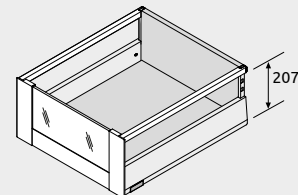

**Spoelbaklade en enkele sifonlade**

SPOELBAKLADE

MS

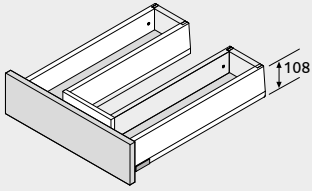

KS

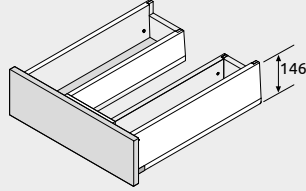

ES boxcap

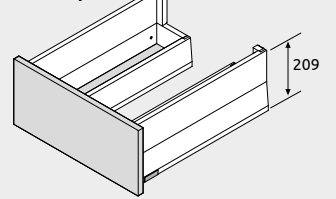

ES boxcover

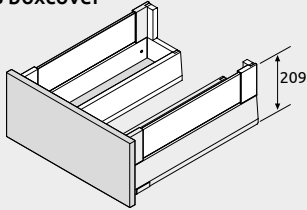

ES reling

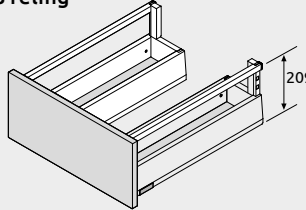

ENKELE SIFONLADE

MY

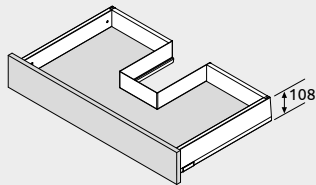

KY

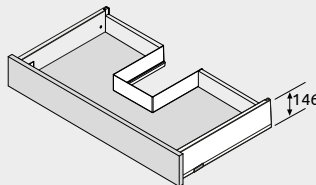

EY boxcap

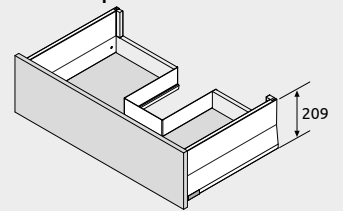

EY boxcover

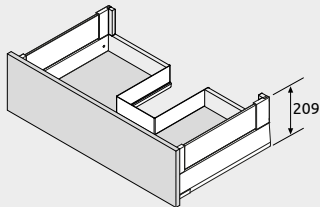

EY reling

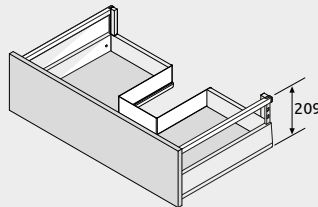

Enkele sifonlade en dubbele sifonlade

ENKELE SIFONBINNENLADE

MY/Z

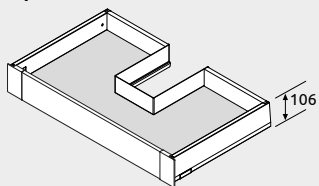

KY/Z

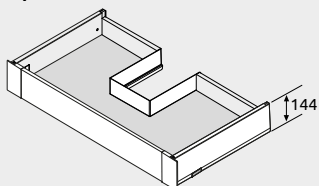

EY/Z boxcap - reling

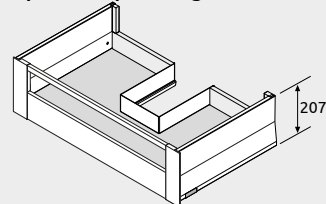

EY/Z boxcap - laag glas

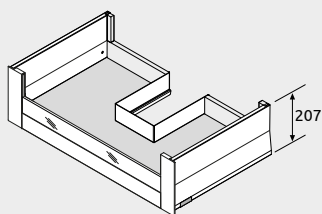

EY/Z boxcap - hoog glas

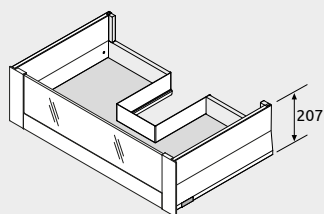

EY/Z boxcover - reling

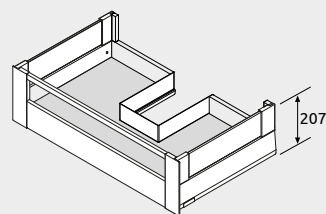

EY/Z boxcover - laag glas

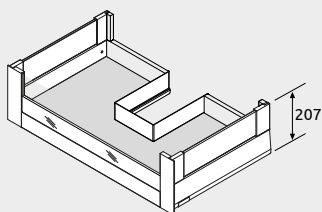

EY/Z boxcover - hoog glas

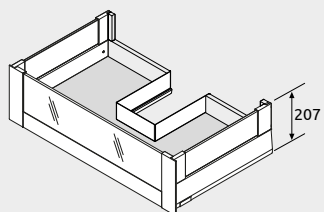

EY/Z reling - reling

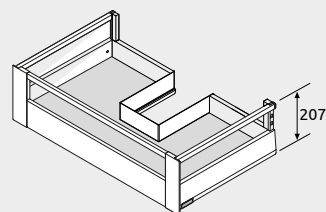

EY/Z reling - laag glas

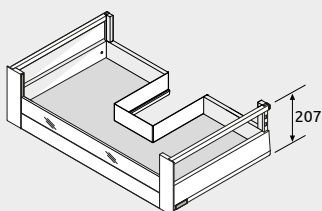

EY/Z reling - hoog glas

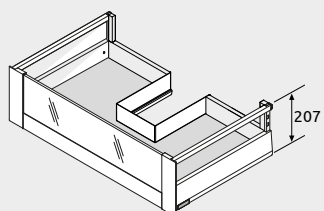

DUBBELE SIFONLADE

MY2

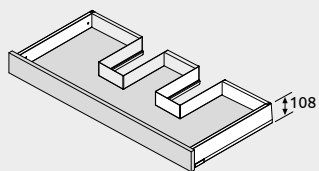

KY2

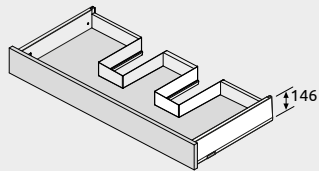

EY2 reling

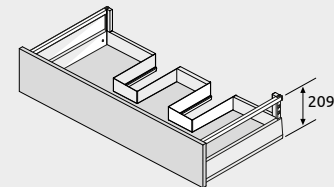

EY2 boxcap

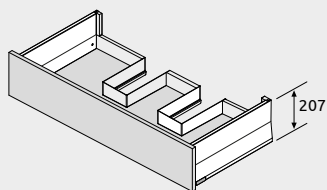

EY2 boxcover

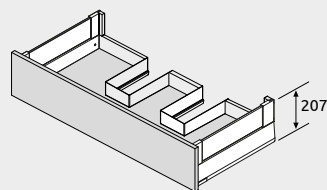

Dubbele sifonlade

DUBBELE SIFONBINNENLADE

MY2/Z

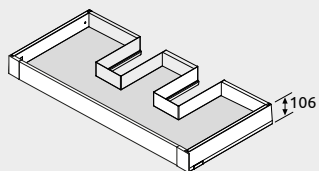

KY2/Z

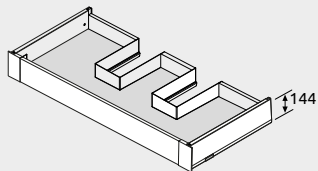

EY2/Z boxcap - reling

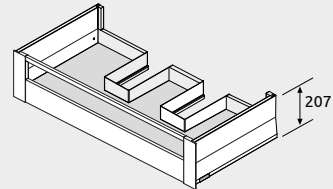

EY2/Z boxcap - laag glas

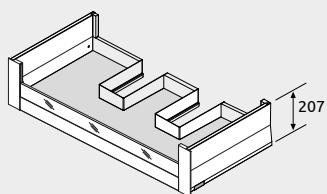

EY2/Z boxcap - hoog glas

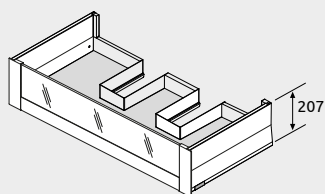

EY2/Z boxcover - reling

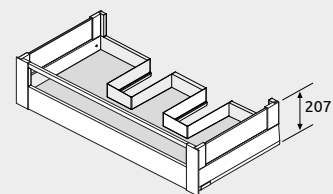

EY2/Z boxcover - laag glas

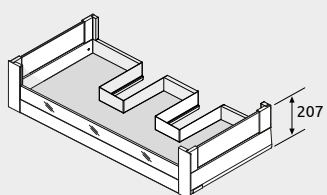

EY2/Z boxcover - hoog glas

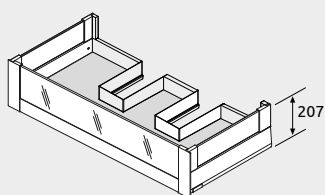

EY2/Z reling - reling

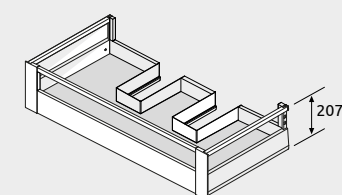

EY2/Z reling - laag glas

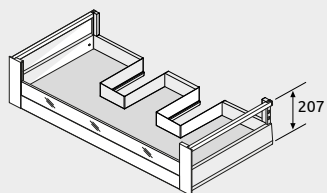

EY2/Z reling - hoog glas

